

PROJECT
TYPE
SPECIFIER
QUANTITY
DATE

## SPRING STANDARD SURFACE

### E9F110-

base number	Color	Finish	Lens
	Temperature	Options	Options

- To build a product code in our configurator select the specify button on the base model # product page
- To build a manual product code on this datasheet choose from the options listed below in blue font and add the suffix to the base model #

#### GENERAL

Series: Spring
Subseries: Spring Standard
Brand: Platek
Division: Exterior
Mounting Type: Surface
Mounting Location: Above Ground
Subcategory: Flood

#### PHYSICAL

Shape: Cone
Diameter (mm): 200
Diameter (in): 7 7/8
Length (mm): 300
Length (in): 11 13/16
Light Distribution: Adjustable / Direct
Diffuser: Clear tempered glass
Fixture Finish: <a href="#">BLK</a> / <a href="#">WHI</a> / <a href="#">GRY</a> / <a href="#">COR</a> / <a href="#">ANT</a> / <a href="#">BRZ</a>
Fixture Material: Aluminum Die Cast

#### ELECTRICAL

Lamp Type: LED
Input Wattage (W): 44
Total Output Wattage (W): 40.5
Dimming: Non-Dimmable
Driver Included: Yes
Driver Location: Integrated
Driver Type: Constant Current - 120Vac
Driver Class: Class 2
Input Voltage (V): 120 - 277
Constant Current (mA): 2100
Upon Request: (Not included - see components [IP65 or higher enclosure to be supplied by others]) Remote: 0-10Vdc dimming / Non-dimming 120/277Vac

#### LED

Number of LEDs: 18
Color Temperature (°K): <a href="#">3000</a> / <a href="#">4000</a>
Max. Delivered Lumen (lm): 3555 - 4000 / 3700 - 4160
Nominal Lumen (lm): 4500 / 4680
CRI: >80 CRI
Lamp Life (hrs): 60000

#### OPTICAL

Optic°: <a href="#">9</a> / <a href="#">28</a> / <a href="#">40</a>
Adjustability: Tilt +195° / - 15°

#### RATINGS AND CERTIFICATIONS

Certified By: Certified for North American Standards
IP rating: IP65
IK Rating: IK06



## SPRING STANDARD SURFACE

E9F110-

PROJECT \_\_\_\_\_

TYPE \_\_\_\_\_

SPECIFIER \_\_\_\_\_

QUANTITY \_\_\_\_\_

DATE \_\_\_\_\_



E

## SPRING MINI SURFACE

### E9F134-

base number    Color    Finish    Lens  
 Temperature    Options    Options

- To build a product code in our configurator select the specify button on the base model # product page
- To build a manual product code on this datasheet choose from the options listed below in blue font and add the suffix to the base model #

#### GENERAL

Series: Spring  
 Subseries: Spring Mini  
 Brand: Platek  
 Division: Exterior  
 Mounting Type: Surface  
 Mounting Location: Above Ground  
 Subcategory: Flood

#### PHYSICAL

Shape: Cone  
 Diameter (mm): 147  
 Diameter (in): 5 <sup>13</sup>/<sub>16</sub>  
 Length (mm): 235  
 Length (in): 9 <sup>1</sup>/<sub>4</sub>  
 Light Distribution: Adjustable / Direct  
 Weight (kg): 2.8  
 Weight (lbs): 6.17  
 Screws: A4 stainless steel  
 Diffuser: Clear tempered glass  
 Gasket: Gore (R) valve  
 Fixture Finish: [BLK](#) / [WHI](#) / [GRY](#) / [COR](#) / [ANT](#) / [BRZ](#)  
 Fixture Material: Aluminum

#### ELECTRICAL

Lamp Type: LED  
 Input Wattage (W): 22  
 Total Output Wattage (W): 20.5  
 Dimming: Non-Dimming / Phase Dimming (120vac Only)  
 Driver Included: Yes  
 Driver Location: Integrated  
 Driver Type: Constant Current - Universal  
 Driver Class: Class 2  
 Input Voltage (V): 120 - 277  
 Constant Current (MA): 700  
 Upon Request: Remote: 0-10Vdc dimming

#### LED

Number of LEDs: 9  
 Color Temperature (°K): [3000](#) / [4000](#)  
 Max. Delivered Lumen (lm): 1780 - 2000 / 1850 - 2080  
 Nominal Lumen (lm): 2250 / 2433  
 CRI: >80 CRI  
 Lamp Life (hrs): 60000

#### OPTICAL

Optic°: [9](#) / [28](#) / [45](#)  
 Adjustability: Tilt +195° / - 15°

#### RATINGS AND CERTIFICATIONS

Certified By: Certified for North American Standards  
 IP rating: IP65  
 IK Rating: IK06

PROJECT
TYPE
SPECIFIER
QUANTITY
DATE



147mm 5 <sup>13</sup>/<sub>16</sub>"



80mm 3 <sup>1</sup>/<sub>8</sub>"

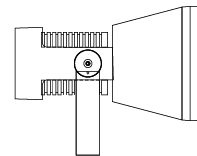

195°  
15°

30mm 1 <sup>13</sup>/<sub>16</sub>"

235mm 5 <sup>1</sup>/<sub>4</sub>"



E9F134-

PROJECT

TYPE

SPECIFIER

QUANTITY

DATE



E

## SPRING MICRO SURFACE

### E9F149-

base number    Color    Finish    Lens  
 Temperature    Options    Options

- To build a product code in our configurator select the specify button on the base model # product page
- To build a manual product code on this datasheet choose from the options listed below in blue font and add the suffix to the base model #

#### GENERAL

Series: Spring  
 Subseries: Spring Micro  
 Brand: Platek  
 Division: Exterior  
 Mounting Type: Surface  
 Mounting Location: Above Ground  
 Subcategory: Flood

#### PHYSICAL

Shape: Cone  
 Diameter (mm): 80  
 Diameter (in): 3 1/8  
 Length (mm): 145  
 Length (in): 5 11/16  
 Height (mm): 50  
 Height (in): 2 3/16  
 Light Distribution: Adjustable / Direct  
 Weight (kg): 0.8  
 Weight (lbs): 1.76  
 Screws: A4 stainless steel  
 Diffuser: Clear tempered glass  
 Fixture Finish: [BLK](#) / [WHI](#) / [GRY](#) / [COR](#) / [ANT](#) / [BRZ](#)  
 Fixture Material: Aluminum Die Cast

#### ELECTRICAL

Lamp Type: LED  
 Input Wattage (W): 5.9  
 Total Output Wattage (W): 4.5  
 Dimming: Non-Dimmable  
 Driver Included: Yes  
 Driver Location: Integrated  
 Driver Type: Constant Current - 120Vac  
 Driver Class: Class 2  
 Input Voltage (V): 120 - 277  
 Constant Current (MA): 500  
 Upon Request: (Not included - see components [IP65 or higher enclosure to be supplied by others]) 0-10Vdc dimming / Phase dimming @120Vac only / Non-dimming 120/277Vac / DMX

#### LED

Number of LEDs: 3  
 Color Temperature (°K): [3000](#) / [4000](#)  
 Max. Delivered Lumen (lm): 435 - 465 / 440 - 485  
 Nominal Lumen (lm): 570 / 600  
 CRI: >80 CRI  
 Lamp Life (hrs): 60000

#### OPTICAL

Optic°: [12](#) / [33](#) / [44](#)  
 Adjustability: Tilt +195° / - 15°

#### RATINGS AND CERTIFICATIONS

Certified By: Certified for North American Standards  
 IP rating: IP65  
 IK Rating: IK06

PROJECT
TYPE
SPECIFIER
QUANTITY
DATE



80mm 3 1/8"

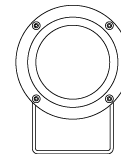

55mm 2 3/16"

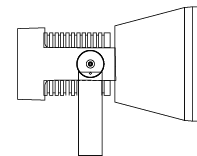

195°  
15°

20mm 13/16"

145mm 5 11/16"



E9F149-

PROJECT

TYPE

SPECIFIER

QUANTITY

DATE



E

PROJECT	_____
TYPE	_____
SPECIFIER	_____
QUANTITY	_____
DATE	_____

## SPRING STANDARD SURFACE

### E9F223-

base number	Color	Finish	Lens
	Temperature	Options	Options

- To build a product code in our configurator select the specify button on the base model # product page
- To build a manual product code on this datasheet choose from the options listed below in blue font and add the suffix to the base model #

#### GENERAL

Series: Spring
Subseries: Spring Standard
Brand: Platek
Division: Exterior
Mounting Type: Surface
Mounting Location: Above Ground
Subcategory: Flood

#### PHYSICAL

Shape: Cone
Diameter (mm): 200
Diameter (in): 7 7/8
Length (mm): 300
Length (in): 11 13/16
Light Distribution: Adjustable / Direct
Weight (kg): 4.8
Weight (lbs): 10.58
Diffuser: Clear tempered glass
Fixture Finish: <a href="#">BLK</a> / <a href="#">WHI</a> / <a href="#">GRY</a> / <a href="#">COR</a> / <a href="#">ANT</a> / <a href="#">BRZ</a>
Fixture Material: Aluminum Die Cast

#### ELECTRICAL

Lamp Type: LED
Input Wattage (W): 45.2
Total Output Wattage (W): 17
Dimming: Non-Dimming / Phase Dimming (120vac Only)
Driver Included: Yes
Driver Location: Integrated
Driver Type: Constant Current - Universal
Driver Class: Class 2
Input Voltage (V): 120 - 277
Constant Current (MA): 1050
Upon Request: Remote: 0-10Vdc dimming

#### LED

Number of LEDs: 1
Color Temperature (°K): <a href="#">3000</a> / <a href="#">4000</a>
Max. Delivered Lumen (lm): 4480 - 4540 / 4660 - 4720
Nominal Lumen (lm): 5300 / 5512
CRI: >80 CRI
Lamp Life (hrs): 60000

#### OPTICAL

Optic°: <a href="#">13</a> / <a href="#">44</a>
Adjustability: Tilt +195° / - 15°

#### RATINGS AND CERTIFICATIONS

Certified By: Certified for North American Standards
IP rating: IP65
IK Rating: IK06

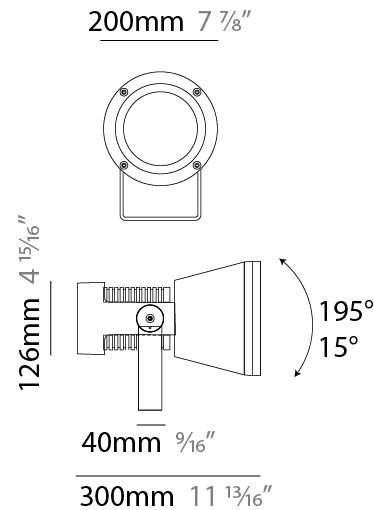

E9F223-

PROJECT

TYPE

SPECIFIER

QUANTITY

DATE

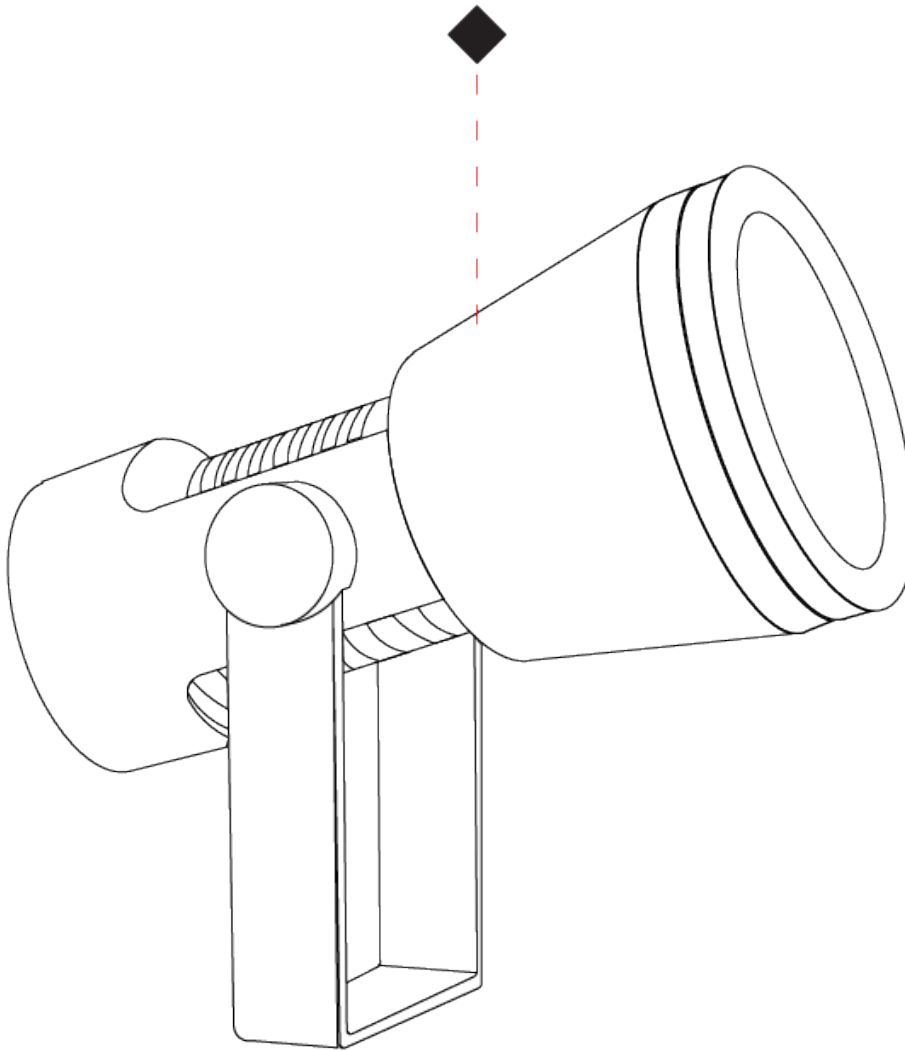

E



## SPRING MINI SURFACE

### E9F266-

base number    Color    Finish    Lens  
 Temperature    Options    Options

- To build a product code in our configurator select the specify button on the base model # product page
- To build a manual product code on this datasheet choose from the options listed below in blue font and add the suffix to the base model #

#### GENERAL

Series: Spring  
 Subseries: Spring Mini  
 Brand: Platek  
 Division: Exterior  
 Mounting Type: Surface  
 Mounting Location: Above Ground  
 Subcategory: Flood

#### PHYSICAL

Shape: Cone  
 Diameter (mm): 147  
 Diameter (in): 5 <sup>13</sup>/<sub>16</sub>  
 Length (mm): 235  
 Length (in): 9 <sup>1</sup>/<sub>4</sub>  
 Light Distribution: Adjustable / Direct  
 Weight (kg): 2.8  
 Weight (lbs): 6.17  
 Screws: A4 stainless steel  
 Diffuser: Clear tempered glass  
 Fixture Finish: [BLK](#) / [WHI](#) / [GRY](#) / [COR](#) / [ANT](#) / [BRZ](#)  
 Fixture Material: Aluminum Die Cast

#### ELECTRICAL

Lamp Type: LED  
 Input Wattage (W): 19  
 Total Output Wattage (W): 18  
 Dimming: Non-Dimming / Phase Dimming (120vac Only)  
 Driver Included: Yes  
 Driver Location: Integrated  
 Driver Type: Constant Current - Universal  
 Driver Class: Class 2  
 Input Voltage (V): 120 - 277  
 Constant Current (MA): 500  
 Upon Request: (Not included - see components [IP65 or higher enclosure to be supplied by others]) Remote: 0-10Vac dimming

#### LED

Color Temperature (°K): [3000](#) / [4000](#)  
 Max. Delivered Lumen (lm): 1700 - 1860 / 1770 - 1934  
 Nominal Lumen (lm): 2340 / 2433  
 CRI: >80 CRI  
 Lamp Life (hrs): 60000

#### OPTICAL

Optic°: [20](#) / [36](#) / [54](#)  
 Adjustability: Tilt +195° / - 15°

#### RATINGS AND CERTIFICATIONS

Certified By: Certified for North American Standards  
 IP rating: IP65  
 IK Rating: IK06

PROJECT
TYPE
SPECIFIER
QUANTITY
DATE



147mm 5 <sup>13</sup>/<sub>16</sub>"

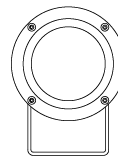

80mm 3 <sup>1</sup>/<sub>8</sub>"

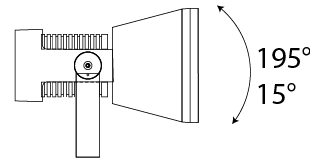

30mm 1 <sup>13</sup>/<sub>16</sub>"

235mm 5 <sup>1</sup>/<sub>4</sub>"



E9F266-

PROJECT	_____
TYPE	_____
SPECIFIER	_____
QUANTITY	_____
DATE	_____

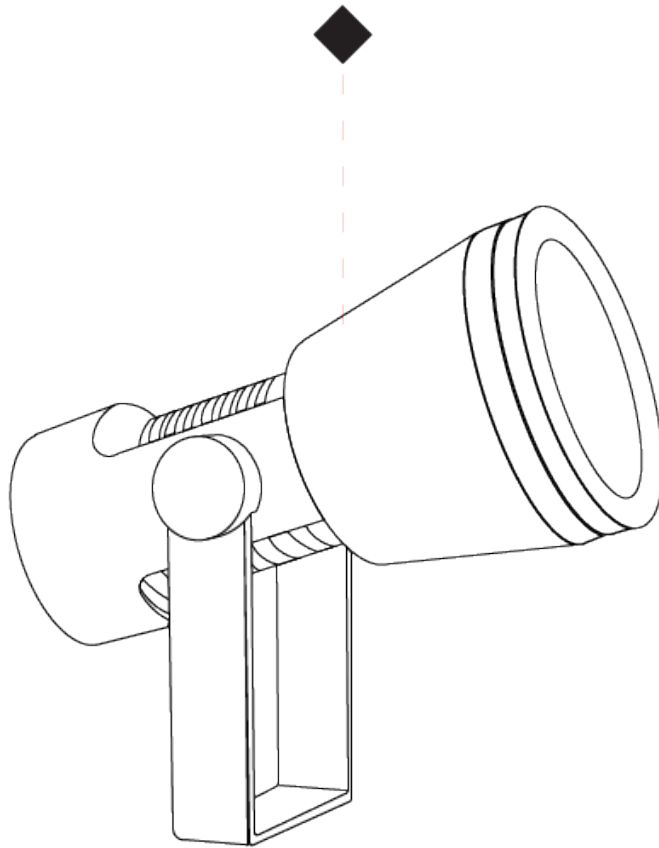

E

PROJECT	_____
TYPE	_____
SPECIFIER	_____
QUANTITY	_____
DATE	_____

## SPRING STANDARD SURFACE

### E9F398-

base number	Finish	Lens
	Options	Options

- To build a product code in our configurator select the specify button on the base model # product page
- To build a manual product code on this datasheet choose from the options listed below in blue font and add the suffix to the base model #

#### GENERAL

Series: Spring
Subseries: Spring Standard
Brand: Platek
Division: Exterior
Mounting Type: Surface
Mounting Location: Above Ground
Subcategory: Flood

#### PHYSICAL

Shape: Cone
Diameter (mm): 200
Diameter (in): 7 7/8
Length (mm): 300
Length (in): 11 13/16
Light Distribution: Adjustable / Direct
Weight (kg): 4.8
Weight (lbs): 10.58
Diffuser: Clear tempered glass
Fixture Finish: <a href="#">BLK / WHI / GRY / COR / ANT / BRZ</a>
Fixture Material: Aluminum Die Cast

#### ELECTRICAL

Lamp Type: LED
Total Output Wattage (W): 35
Dimming: Bluetooth technology or DMX
Control Gear: DMX
Driver Included: No
Driver Location: Remote
Driver Type: Constant Current - Universal
Driver Class: Class 2
Input Voltage (V): 120 - 277
Constant Current (MA): 500

#### LED

Number of LEDs: 24
Color Temperature (°K): RGBW
CRI: >80 CRI
Lamp Life (hrs): 60000
Special LEDs offerings: RGBW

#### OPTICAL

Optic°: <a href="#">9 / 28 / 45</a>
Adjustability: Tilt +195° / - 15°

#### RATINGS AND CERTIFICATIONS

Certified By: Certified for North American Standards
IP rating: IP65
IK Rating: IK06

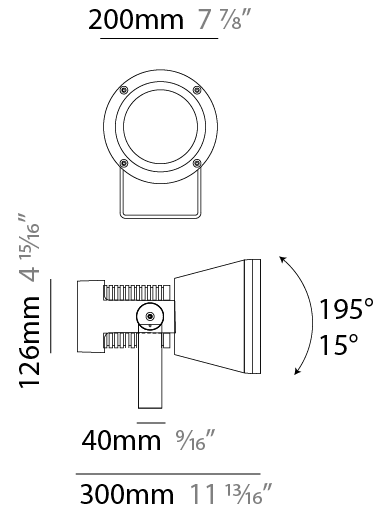

## SPRING STANDARD SURFACE

E9F398-

PROJECT

TYPE

SPECIFIER

QUANTITY

DATE



E

## SPRING MINI SURFACE

### E9F399-

base number    Finish Options    Lens Options

- To build a product code in our configurator select the specify button on the base model # product page
- To build a manual product code on this datasheet choose from the options listed below in blue font and add the suffix to the base model #

#### GENERAL

Series: Spring  
 Subseries: Spring Mini  
 Brand: Platak  
 Division: Exterior  
 Mounting Type: Surface  
 Mounting Location: Above Ground  
 Subcategory: Flood

#### PHYSICAL

Shape: Cone  
 Length (mm): 235  
 Length (in): 9 1/4  
 Width (mm): 147  
 Width (in): 5 13/16  
 Height (mm): 165  
 Height (in): 6 1/2  
 Light Distribution: Adjustable / Direct  
 Weight (kg): 2.8  
 Weight (lbs): 6.17  
 Screws: A4 stainless steel  
 Diffuser: Serigraphed extra-clear glass  
 Fixture Finish: [BLK](#) / [WHI](#) / [GRY](#) / [COR](#) / [ANT](#) / [BRZ](#)  
 Fixture Material: Aluminum Die Cast

#### ELECTRICAL

Lamp Type: LED  
 Total Output Wattage (W): 16  
 Dimming: Bluetooth technology or DMX  
 Control Gear: DMX  
 Driver Included: No  
 Driver Location: Remote  
 Driver Type: Constant Current - Universal  
 Driver Class: Class 2  
 Input Voltage (V): 120 - 277  
 Constant Current (MA): 350

#### LED

Number of LEDs: 16  
 Color Temperature (°K): RGBW  
 CRI: >80 CRI  
 Lamp Life (hrs): 60000  
 Special LEDs offerings: RGBW

#### OPTICAL

Optic°: [9 / 28 / 45](#)  
 Adjustability: Tilt +195° / - 15°

#### RATINGS AND CERTIFICATIONS

Certified By: Certified for North American Standards  
 IP rating: IP66  
 IK Rating: IK06

PROJECT
TYPE
SPECIFIER
QUANTITY
DATE



147mm 5 13/16"

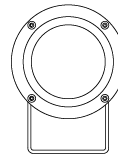

80mm 3 1/8"

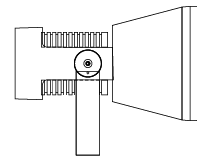

195°  
15°

30mm 1 13/16"

235mm 5 1/4"



E9F399-

PROJECT	_____
TYPE	_____
SPECIFIER	_____
QUANTITY	_____
DATE	_____

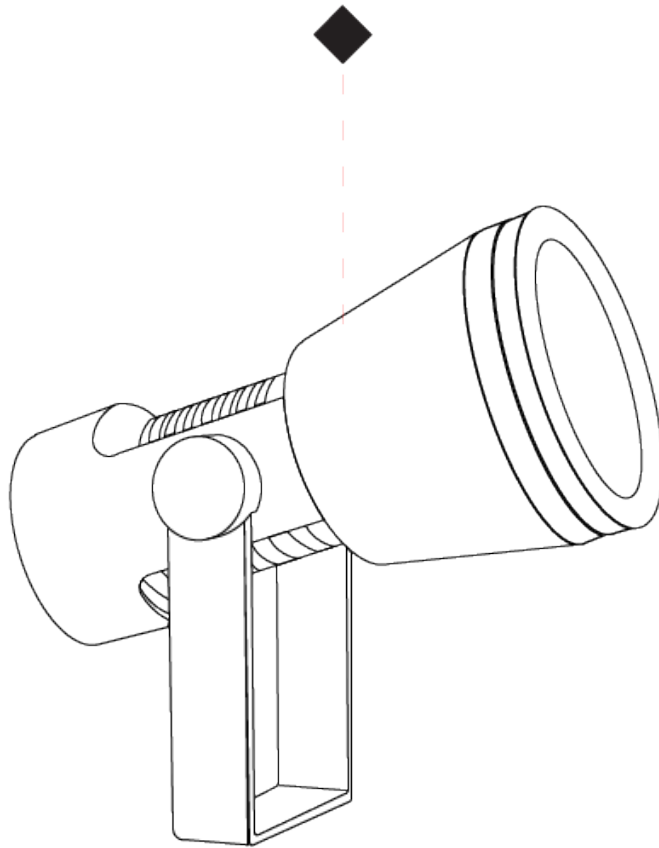

E

## SPRING MICRO SURFACE

### E9F400-

base number    Finish Options    Lens Options

- To build a product code in our configurator select the specify button on the base model # product page
- To build a manual product code on this datasheet choose from the options listed below in blue font and add the suffix to the base model #

#### GENERAL

Series: Spring  
 Subseries: Spring Micro  
 Brand: Platek  
 Division: Exterior  
 Mounting Type: Surface  
 Mounting Location: Above Ground  
 Subcategory: Flood

#### PHYSICAL

Shape: Cone  
 Diameter (mm): 80  
 Diameter (in): 3 1/8  
 Length (mm): 145  
 Length (in): 5 11/16  
 Height (mm): 50  
 Height (in): 2 3/16  
 Light Distribution: Adjustable / Direct  
 Weight (kg): 2.8  
 Weight (lbs): 6.17  
 Screws: A4 stainless steel  
 Diffuser: Serigraphed extra-clear glass  
 Fixture Finish: [BLK](#) / [WHI](#) / [GRY](#) / [COR](#) / [ANT](#) / [BRZ](#)  
 Fixture Material: Aluminum Die Cast

#### ELECTRICAL

Lamp Type: LED  
 Total Output Wattage (W): 16  
 Dimming: Bluetooth technology or DMX  
 Control Gear: DMX  
 Driver Included: No  
 Driver Location: Remote  
 Driver Type: Constant Current - Universal  
 Driver Class: Class 2  
 Input Voltage (V): 120 - 277  
 Constant Current (MA): 350

#### LED

Number of LEDs: 16  
 Color Temperature (°K): RGBW  
 CRI: >80 CRI  
 Lamp Life (hrs): 60000  
 Special LEDs offerings: RGBW

#### OPTICAL

Optic°: [12](#) / [33](#) / [44](#)  
 Adjustability: Tilt +195° / - 15°

#### RATINGS AND CERTIFICATIONS

Certified By: Certified for North American Standards  
 IP rating: IP66  
 IK Rating: IK06

PROJECT
TYPE
SPECIFIER
QUANTITY
DATE



80mm 3 1/8"

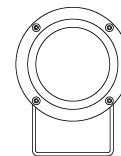

55mm 2 3/16"

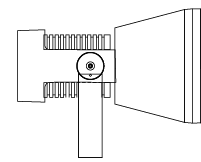

195°  
15°

20mm 13/16"

145mm 5 11/16"



E9F400-

PROJECT	_____
TYPE	_____
SPECIFIER	_____
QUANTITY	_____
DATE	_____

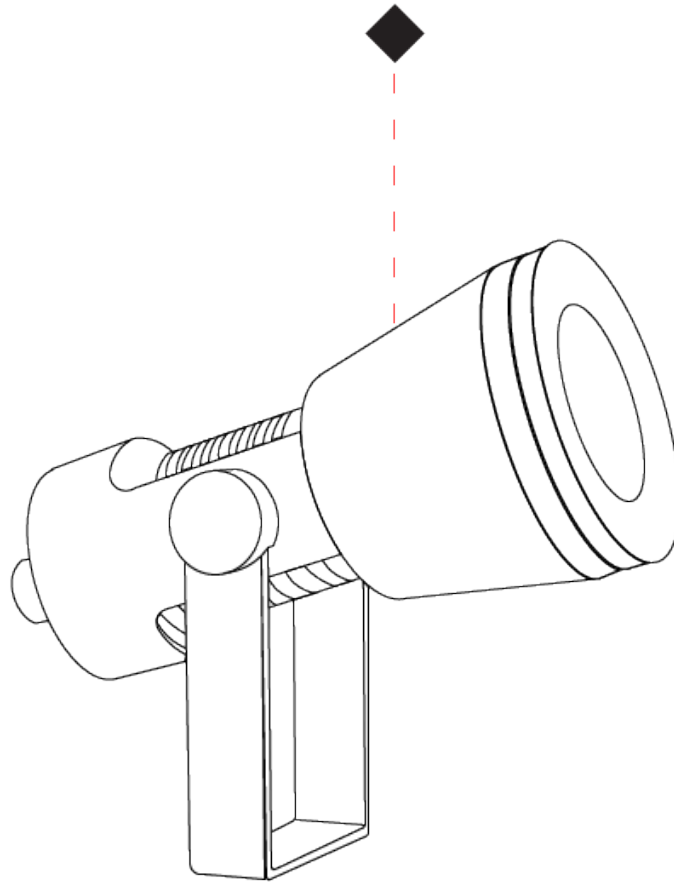

E



PROJECT	_____
TYPE	_____
SPECIFIER	_____
QUANTITY	_____
DATE	_____

### Fixture Finish

Black - BLK



White - WHI



Gray - GRY



Corten - COR



Anthracite - ANT



Bronze - BRZ







































































**Digital:** Not all screens are calibrated the same, and therefore, colors will appear differently between screens.

**Physical:** When texture is involved, there will be variations in color, character and tone within a product series and between product families.



PROJECT	
TYPE	
SPECIFIER	
QUANTITY	
DATE	











### LEGEND

	floor-mounted		pivotal		special LED (upon request) RGB, RGBW, tunable, gold+, meat+, art+, fashion+
	wall and ceiling: recessed and surface mounted		rotating		warm dim / natural dimming LED
	ceiling-mounted and wall-mounted		illuminate tilted		rechargeable battery powered
	wall-mounted		color of suspension cable		fixture with natural vivid LED (upon request)
	omni-directional light distribution		length of suspension cable		color rendering index
	direct light distribution		reflector degree selection		color temperature
	direct/indirect light distribution		super spot		lumen (luminous flux)
	indirect light distribution		lens		efficacy (lumens per watt)
	asymmetric light distribution		lens pack		Unified Glare Rating (UGR) range from 5-40
	aura light distribution		shine ring		marine grade (AISI 316 stainless steel)
	round wall or ceiling cut-out		integrated shine ring with diffuser		walk on
	square wall or ceiling cut-out		free individual colors 01-29		drive on
	the supplied jig specifies the cutout dimensions		individual colors: 00 (free of charge), 01-25 (extra charge)		Dark Sky Compliance
	minimum distance (meters) lamp - object		luminaire part to be colored (F1)		Americans with Disabilities Act (less than 4" off the wall located between 27"-84" from floor)
	recessed depth		luminaire part to be colored (F2)		lamp protected against explosion
	ceiling thickness in mm		luminaire part to be colored (F3)		blown glass using traditional methods by master glass blower
	ceiling thickness selection		luminaire part to be colored (F4)		acoustic material
	dimnable DP (phase), DV (0-10V), DD (dali), DS (step-dim)		luminaire part to be colored (F5)		protection class I, protection insulation
	included or excluded LED driver/transformer/control gear		color of 3-circuit adaptor		protection class II, protection insulation
	separately switchable		indirect diffuser		ETL Certified to UL and CSA Standards
	sensor		direct diffuser		UL Certified to UL and CSA Standards
	remote control		ball-proof (upon request)		CSA Certified to UL and CSA Standards
	available upon request		accessory		Certified for North American Standards

### IP RATING

	protected against ingress of solid bodies greater than 12.5mm (finger)
	protected against ingress of solid bodies greater than 2.5mm protected against sprays of water up to 60 degrees from the vertical (rain)
	protected against ingress of solid bodies greater than 1mm (wire) no protection against the ingress of moisture
	protected against ingress of solid bodies greater than 1mm (wire) protected against sprays of water up to 60 degrees from the vertical (rain)
	protected against ingress of solid bodies greater than 1mm (wire) protected against water splashed from all directions
	protected against limited ingress of dust (wet rooms/covered outdoor areas) protected against water splashed from all directions
	protected against ingress of dust protected against jets of water
	protected against ingress of dust protected against powerful jets of water or heavy seas
	protected against ingress of dust protected against immersion of water between 15cm - 1m for 30 minutes
	protected against ingress of dust protected against immersion of water under pressure for long periods

### IK RATING

	protected against 0.14 joules impact (equivalent to 0.25kg mass dropped from 56mm above the surface)
	protected against 0.2 joules impact (equivalent to 0.25kg mass dropped from 80mm above the surface)
	protected against 0.35 joules impact (equivalent to 0.25kg mass dropped from 140mm above the surface)
	protected against 0.5 joules impact (equivalent to 0.25kg mass dropped from 200mm above the surface)
	protected against 0.7 joules impact (equivalent to 0.25kg mass dropped from 280mm above the surface)
	protected against 1 joules impact (equivalent to 0.25kg mass dropped from 400mm above the surface)
	protected against 2 joules impact (equivalent to 0.5kg mass dropped from 400mm above the surface)
	protected against 5 joules impact (equivalent to 1.7kg mass dropped from 300mm above the surface)
	protected against 10 joules impact (equivalent to 5.0kg mass dropped from 200mm above the surface)
	protected against 20 joules impact (equivalent to 5.0kg mass dropped from 400mm above the surface)